

cell 220-9

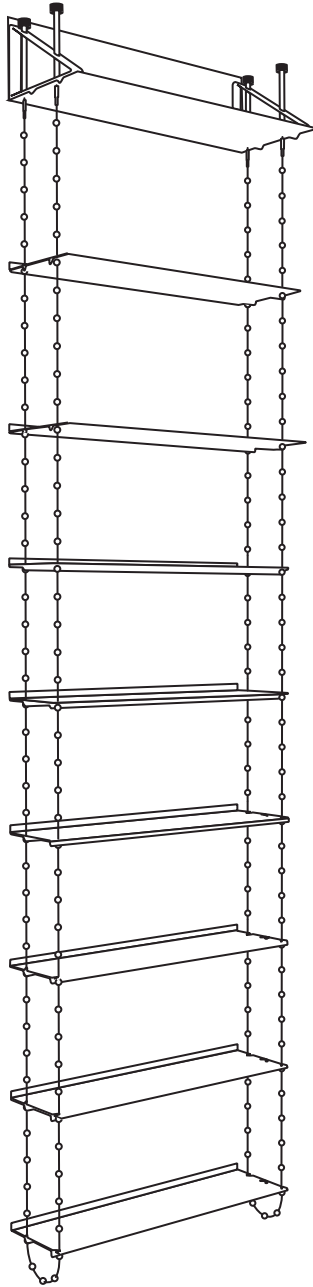

cell 175-7

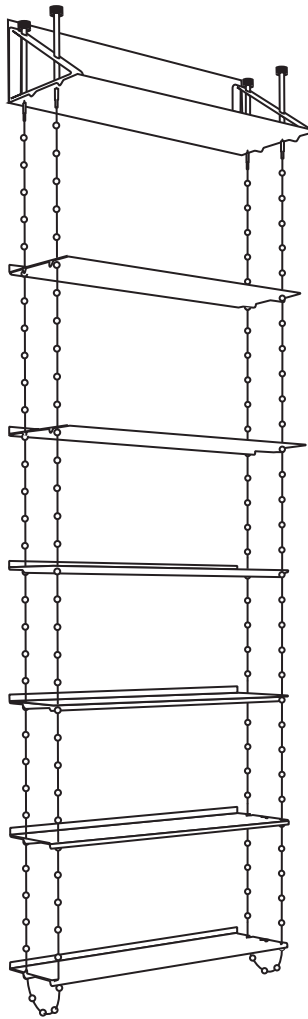

cell 110-7

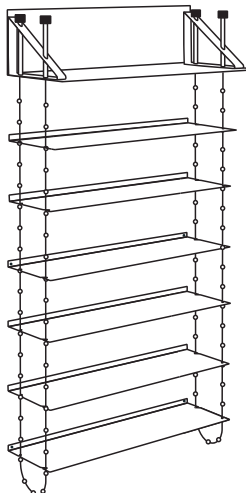

cell 110-4

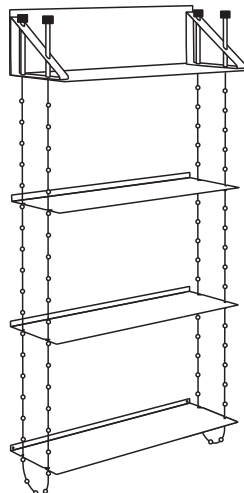

cell 80-3

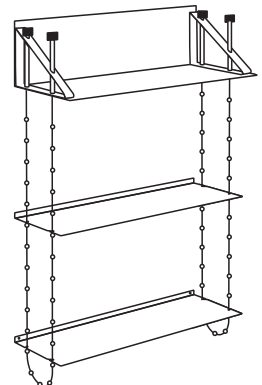

1

ENG
Cell can be mounted on most walls. Use the best screw system available for the wall used. Always get advice on suitable screw systems from your local specialized dealer. If you are uncertain of the quality of your wall consult a specialist.

Cell 220-9 mounting height
240 cm ceiling height: Set the distance between the ceiling and the upper edge of the fastening rail to 9 cm.
250 cm ceiling height: Set the distance between the ceiling and the upper edge of the fastening rail to 15 cm.
For ceilings higher than 250 cm the distance between the floor and the bottom shelf can be 30 - 50 cm. See measures on the back of this instruction.

SV
Cell kan monteras på de flesta väggar. Använd alltid bästa tillgängliga skruvsystem för den aktuella väggtypen. Kontakta alltid din lokala fackhandlare för råd om lämpligt skruvsystem. Är du osäker på väggkvaliteten kontakta en specialist för hjälp med monteringen.

Cell 220-9 monteringshöjd
240 cm takhöjd: Avståndet mellan fästskenans överkant och taket ska vara 9 cm.
250 cm takhöjd: Avståndet mellan fästskenans överkant och taket ska vara 15 cm.
Med en takhöjd över 250 cm kan avståndet mellan nedersta hyllplanet och golvet vara 30 - 50 cm. Se mått på baksidan av monteringsanvisningen.

SINGLE SECTION / ENKELSEKTION

USE WATER-LEVELLER / ANVÄND VATTENPASS

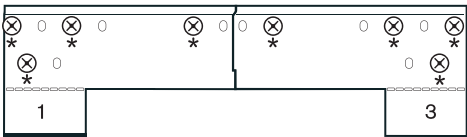

MULTIPLE SECTIONS ON A DOUBLE PLASTER WALL OR OTHER WALL OF HIGH QUALITY / FLERA SEKTIONER PÅ VÄGG AV DUBBELGIPS ELLER ANNAN VÄGG AV HÖG KVALITET

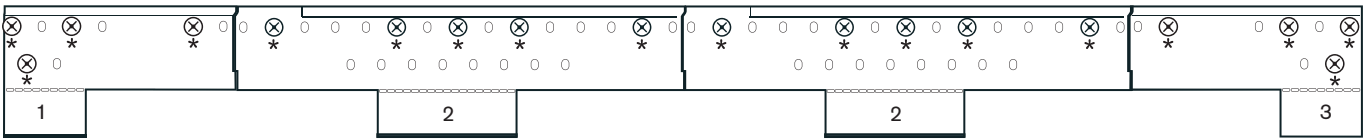

MULTIPLE SECTIONS ON A SINGLE PLASTER WALL / FLERA SEKTIONER PÅ VÄGG AV ENKELGIPS

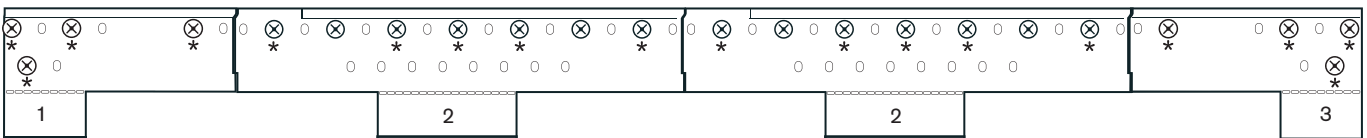

2

ENG
Cell comes in sections. The first, leftmost, section is always an A-section and the following sections are always B-sections.

SV
Cell byggs i sektioner från vänster till höger. Den första sektionen är en A-sektion och alla de följande är B-sektioner.

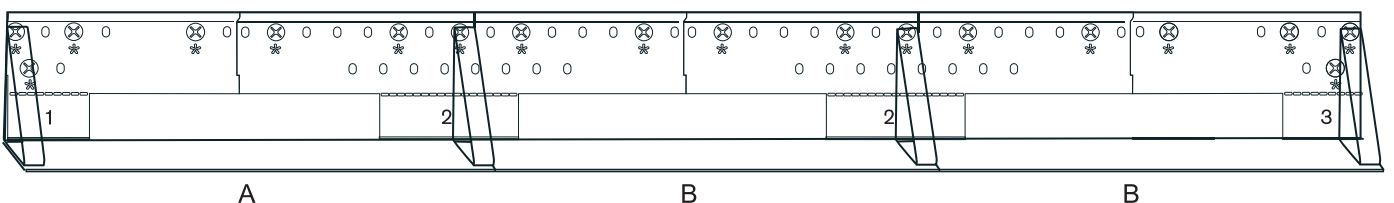

3

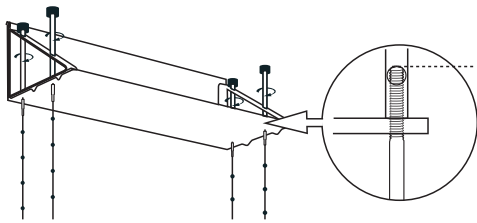

4

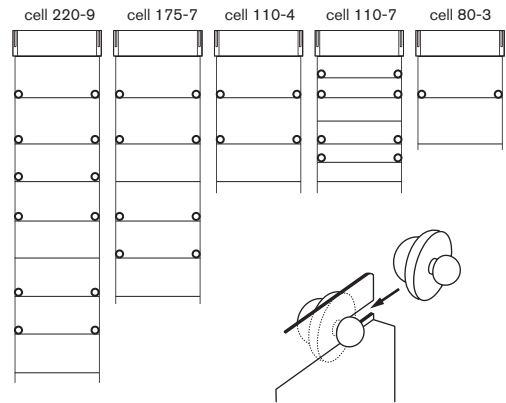

5

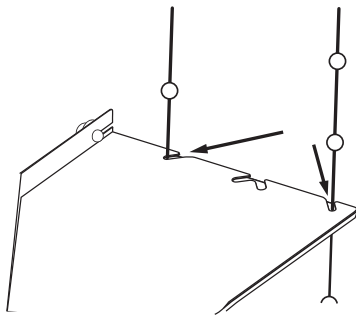

6

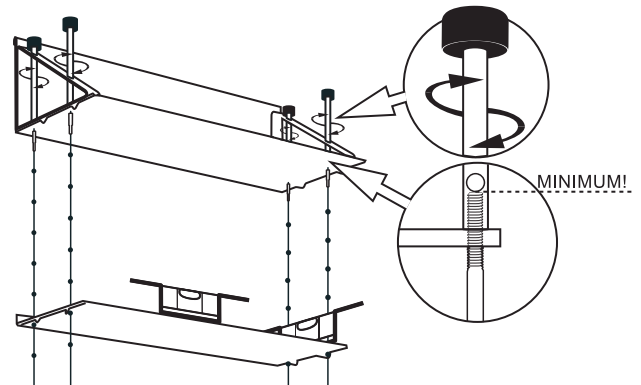

7

ENG

Note! The wall magnet will break if the screw is tightened to hard. Be careful if you use an electrical screwdriver. We recommend manually fastening by hand.

SV

OBS! Vägmmagneten spricker om skruven spänns för hårt. Var därför försiktig om du använder skruvdragare. Helst skall åtdragningen ske för hand.

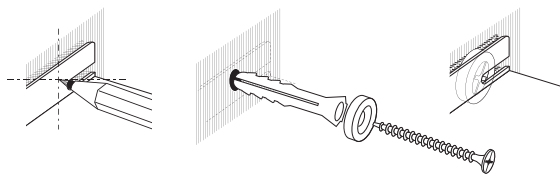

cell 220-9 cell 175-7 cell 110-4 cell 110-7 cell 80-3

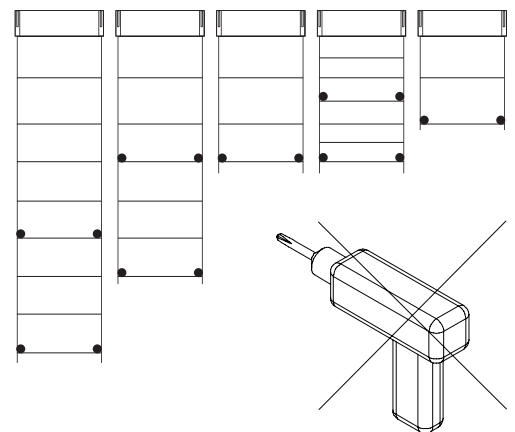

8

MULTIPLE SECTIONS / FLERA SEKTIONER

9

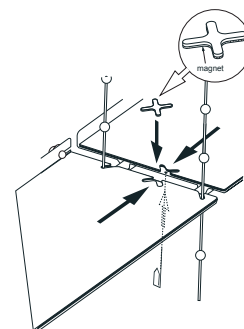
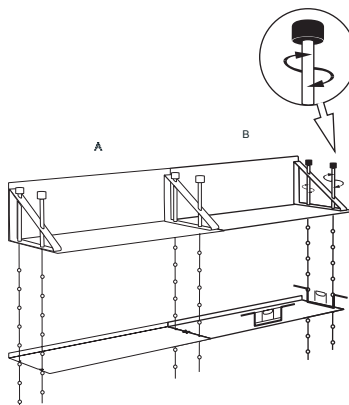

DIMENSIONS / DIMENSIONER

made in sweden by stringfurniture™

cell 220-9

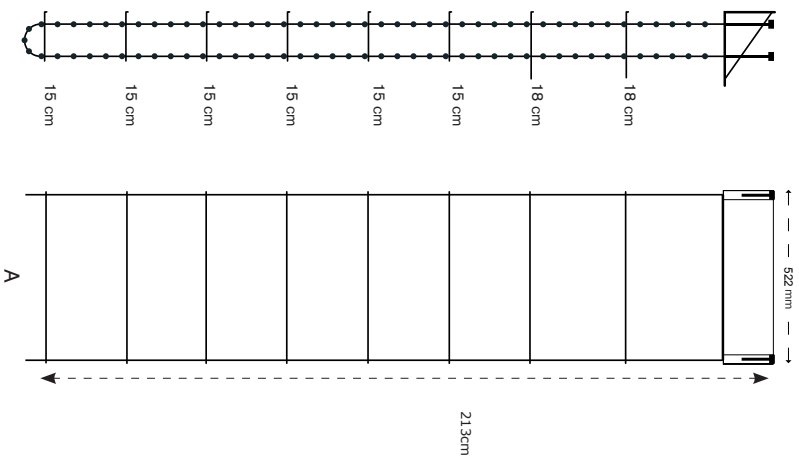

cell 175-7

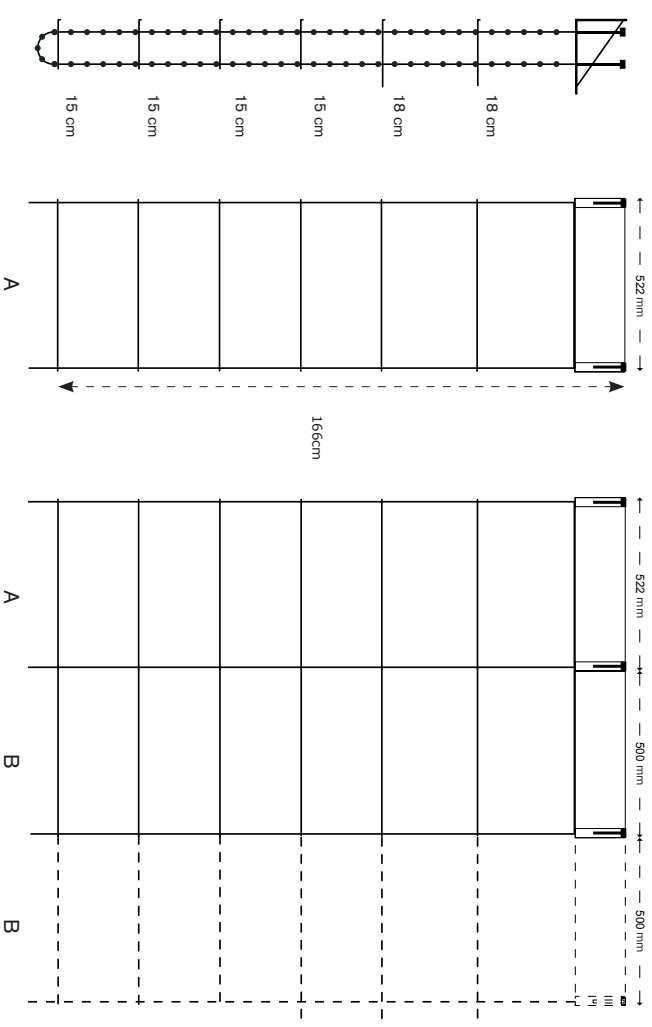

cell 80-3

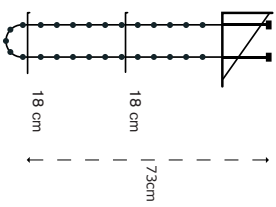

cell 110-4

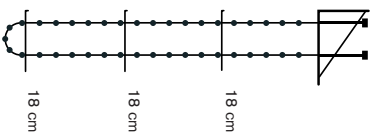

cell 110-7

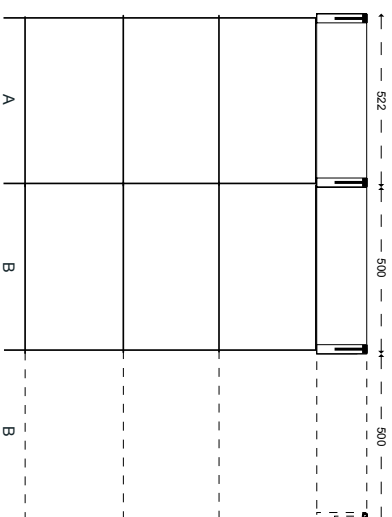
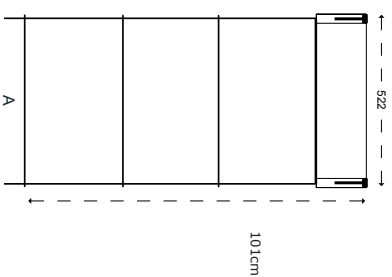
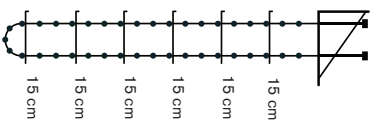

string furniture ab
grimsbygatan 24
211 20 malmö
sweden
t +46 (0)40 18 70 01
f +46 (0)40 611 72 90
info@string.se
www.string.se